



Replacement Parts list

For model

51-RL-P

Howe Corporation

1650 N Elston Ave

Chicago, Il.60642

email: parts@howecorp.com

Service@howecorp.com

Main Tel: 773.235.0200





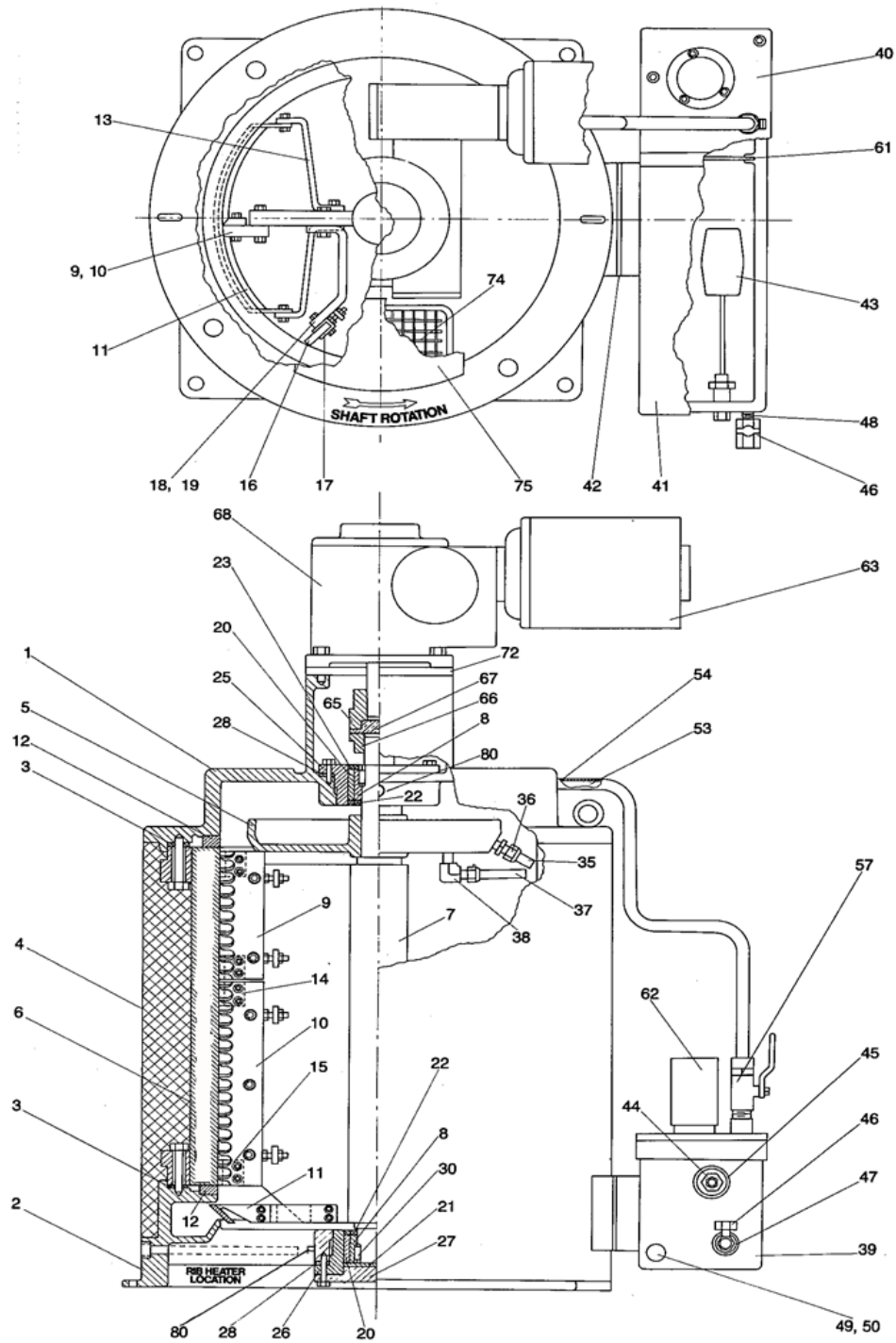







Parts: 773.687-4950









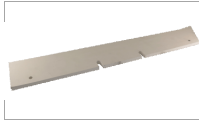

Service: 773.687.4940







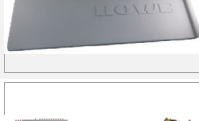
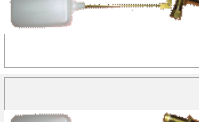
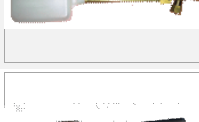





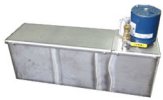









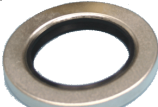





Drwg #	Drwg Ref Num	Part Number	Description	Qty	Image of Part
--------	--------------	-------------	-------------	-----	---------------





51RL-P

	0	53013	Semi Annual maintenance kit (includes cleaner, sanitizer, food grade grease and water filter)	1	
	0	53014	Annual Matenance Kit (includes Cleaner, Sanitiizer, food grade Grease, water filters, and ice blade adjustment kit)	1	
	0	53017	3 year maintenance kit (Includes cleaner, sanitizer, food grade grease, water filter, ice blade adjustment kit, and squeegee)	1	
c	0	53060	Liquid Line Solenoid Valve with Coil	1	
c	44	CNBHF-SG-BR08	Water Float Valve Fitting	1	
b, c	44	CNBHF-SG-BR08	Water Float Valve bulkhead fitting	1	
c	53	CNM-SG-BR14X12	Water Tube Fitting	1	
	0	E10E15	Ice Blade Adjustment gauge Kit (set of 7 gauges)	1	
b	0	E20E7	Axillary Ice Scraper nuts, Bolts & Washers (only)	2	
b	9	E30E3	Ice Blade 20.5" Long	1	
b, c	0	E30E5	Nuts, Bolts & Washers for E30E3 ice blade	1	
b, c	14	E30E6	Top or Bottom Auxillary Scraper	2	
b	0	E30F22	Nuts bolts & Washers for Squeegee Wrapper	1	

Drwg #	Drwg Ref Num	Part Number	Description	Qty Rea	Image of Part
b, c	17	E30F3	Squeegee 20.5" Long	1	
b	0	E30F3-OZ	Squeegee 20.5" Long (Ozone Resistant)	1	
b	18	E30F8	Squeegee Wrapper 20.5" Long	1	
c	7	E50D1	Main Shaft	1	
c	8	E50D2	Shaft Sleeve (SS)	2	
c	18	E50F1	Squeegee Bracket (top)	1	
c	11	E50G5	Ice Deflector Blade	1	
c	13	E50G9	Ice Deflector Bracket	2	
c	5	E50H1	Water Distribution Pan (Tubes not included)	1	
c	40	E50H11	Water Sump Bolt Down Cover (Pump Side)	1	
c	41	E50H15	Water Sump Removeable Cover	1	
b	43	E50H18	Water Float valve	1	
c	43	E50H18	Water Float Valve	1	
c	35	E50H19	Water Distribution Side Spout & Fitting	11	

Drwg #	Drwg Ref Num	Part Number	Description	Qty	Image of Part
c	57	E50H24	Water Tube Regulating Valve	1	
c	37	E50H31	Water Distribution Bottom Spout & fitting	1	
c	53	E50H38-KT	Water Tube Kit with Fitting	1	
c	0	E50H45	Stainless steel sump assembly with pump	1	
c	0	E50H8	Water Sump Tank Cast Aluminum (No covers)	1	
c	0	E50H8-KT	Water Sump Cast Aluminum (with covers)	1	
c	12	E50J1	Insulating Ring	2	
c	3	E50J2	Insulated Lug Spacer	8	
c	42	E50J3	Water Sump Gasket	1	
	0	E50J6	Insulating Ring Repair Tool	1	
c	20	E50K1	Main Shaft Sleeve Bearing	2	
c	0	E50K10	Top Bearing kit (bearing, sleeve & Seals)	1	
c	0	E50K11	Bottom Bearing Kit (bearing, sleeve, seal, & Plate)	1	
c	22	E50K14	Main Bearing Grease Seal (Chrome)	3	

Drwg #	Drwg Ref Num	Part Number	Description	Qty	Image of Part
				Req	
c	21	E50K2	Bottom Bearing Thrust Plate	1	
c	25	E50K3	Top Main Bearing Retainer	1	
c	0	E50K3-KT	Top Bearing retainer assembly, (E50K10, E50K3, & E50K6)	1	
c	26	E50K4	Bottom Main Bearing Retainer	1	
c	0	E50K4-KT	Bottom Bearing retainer assembly (E50K11, E50K4, & E50K6)	1	
c	27	E50K5	Bottom Bearing Cover	1	
c	28	E50K6	Main Bearing Pull-Out Washer	2	
c	63	E50M4	Drive Motor 208-230-460/3/50-60 1 HP TEFC	1	
c	63	E50M5	Drive Motor 220-380/3/50, 1 HP, TEFC	1	
c	63	E50M6	Drive Motor 208-230/1/60, 1 HP, TEFC	1	
c	63	E50M7	Drive Motor 200-220/1/50, 1 HP, TEFC	1	
c	65	E50N1	Flexible Coupling	1	
c	62	E50Q1	Water Pump 230-460/3/50-60	1	
c	62	E50Q2	Water Pump 220-230/1/50-60	1	

Drwg #	Drwg Ref Num	Part Number	Description	Qty	Image of Part	Req
c	62	E50Q9	Water Pump 575/3/60	1		
c	68	E50R1-935	Speed Reducer 60 cycle 750:1	1		
c	68	E50R2-935	Speed Reducer 50 cycle 600:1	1		
c	0	HT500-240-037X80	Replacement Rib Heater 500 wats each	3		
b	0	SR-OIL-SYN	Synthetic Speed reducer oil (Quart)	1	