



Replacement Parts list

For model
1000-SCAE





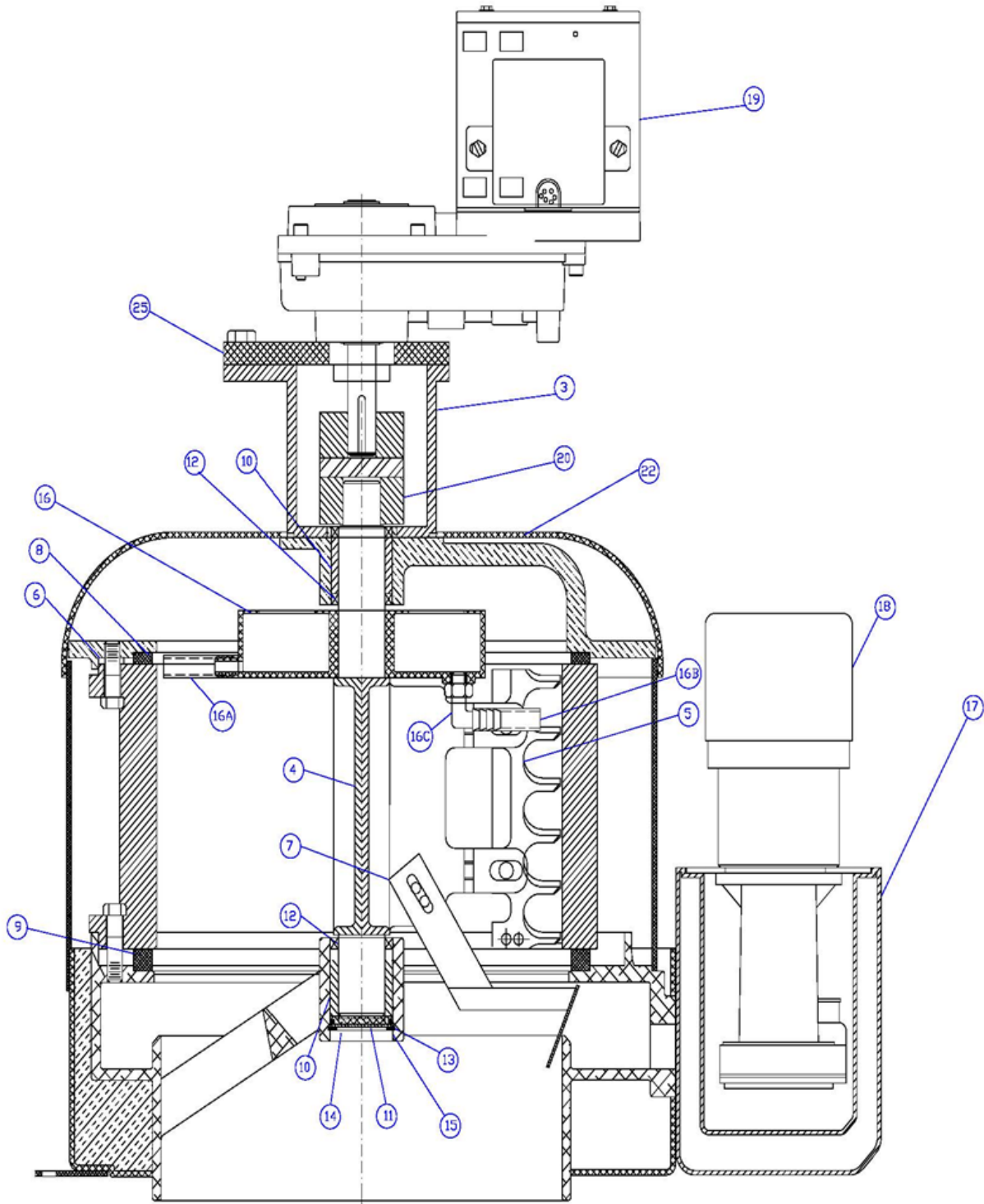









Howe Corporation
1650 N Elston Ave
Chicago, Il.60642
email: parts@howecorp.com
Service@howecorp.com













Main Tel: 773.235.0200
Parts: 773.687-4950
Service: 773.687.4940



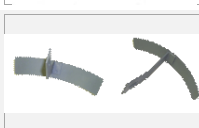













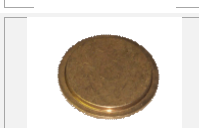

Drwg #	Drwg Ref Num	Part Number	Description	Qty	Image of Part
--------	--------------	-------------	-------------	-----	---------------

1000SCAE

	0	11142	Photo eye set (emitter and receiver) C.G.	1	
	0	11156	Suction pressure transducer	1	
	0	51007	Replacement touchscreen assembly	1	
	0	53009	Semi Annual Maintenance kit (Includes, cleaner, grease,	1	
	0	53010	Annual Maintenance kit (Includes, cleaner, sanitizer, grease, ice blade adjustment kit)	1	
a	0	53034	Ice Deflector Kit (Ice deflector, nuts, bolts & washers)	1	
a	0	53048	Liquid Line Solenoid Valve assembly	1	
	0	E10E15	Ice Blade Adjustment gauge Kit (set of 7 gauges)	1	
a, b	0	E10H59	Water Pump regulating valve	1	
a, b	0	E10H79	Water Float Valve	1	
a	18	E10Q7-P	Replacement Water Pump Assembly w/ mounting plate, ball valve, tubing and Molex plug	1	
a	2	F5A6-KT	Coupling Hub with Hardware	1	
a	25	F5A7	Gearmotor Mounting Adaptor Plate	1	
a	0	F5C17-1	Rotolock sweat adaptor (suction line)	1	

Drwg #	Drwg Ref Num	Part Number	Description	Qty Req	Image of Part
a	0	F5C17-2	Spud - for Rotolock fitting (suction line)	1	
a	0	F5C25	Liquid Line Evaporator connector	1	
a	4	F5D2	Main Shaft (casting)	1	
a	4	F5D4	Main Shaft (Fabricated)	1	
a	5	F5E1	Ice Harvesting Blade	1	
a	0	F5E2	Top/Bottom Auxiliary Ice Scraper	2	
a	0	F5E5	Nuts, Bolts & Washers for Ice Harvesting Blade	1	
a	7	F5G1	Ice Deflector (Old - Obsolete)	1	
a	0	F5G2	Nuts, Bolts & Washers (Ice Deflector)	1	
a	7	F5G3	Ice Deflector	1	
a	0	F5H11-KT	Water Tube kit with Regulating Valve	1	
a	0	F5H18	Water Sump Gasket	1	
a	0	F5H25-4	Water Sump Cover - Removeable access side	1	
a	16	F5H30	Water Distribution Bottom Tube & Fitting	1	

Drwg #	Drwg Ref Num	Part Number	Description	Qty Req	Image of Part
a		F5H31	Low water cutoff switch kit	1	
a	16	F5H5	Water Distribution Pan Assembly	1	
a	16	F5H6	Water Distribution Side Spout Tube	5	
a	0	F5I2	Inspection removeable cover	1	
a	8	F5J4	Top Insulating Ring	1	
a	6	F5J5	Insulating Lug Spacers (Top)	4	
a	0	F5J7	Insulating Lug Spacers (Bottom)	4	
a	9	F5J8	Bottom Insulating Ring	1	
a	10	F5K1	Main Bearing	2	
a	11	F5K2	Bottom Bearing Thrust Plate	1	
a	12	F5K3	Bearing Grease Seals	3	
a	13	F5K4	O-Ring for Bearing disk	1	
a	14	F5K5	Bottom bearing disk	1	
a	15	F5K6	Lock ring for bottom bearing disk	1	

Drwg #	Drwg Ref Num	Part Number	Description	Qty Req	Image of Part
a	0	F5K7	Bearing replacement kit (includes items # 10-15)	1	
a	0	F5M11	Output shaft with snap ring, and keys, 2.5"	1	
a	19	F5M1-KT	Gear Motor Kit (includes, gearmotor, output shaft, adaptor plate, flexible coupling and hardware)	1	
a	20	F5N1	Flexible Coupling	1	