



Máquina de hielo en escamas

Lista de piezas de repuesto
para el
modelo 76RL

Howe Corporation

1650 N Elston Ave

Chicago, Il.60642

email: parts@howecorp.com

Service@howecorp.com

telefono principal: +1.773.235.0200

Partes: +1.773.687-4950

Servicio: +1.773.687.4940

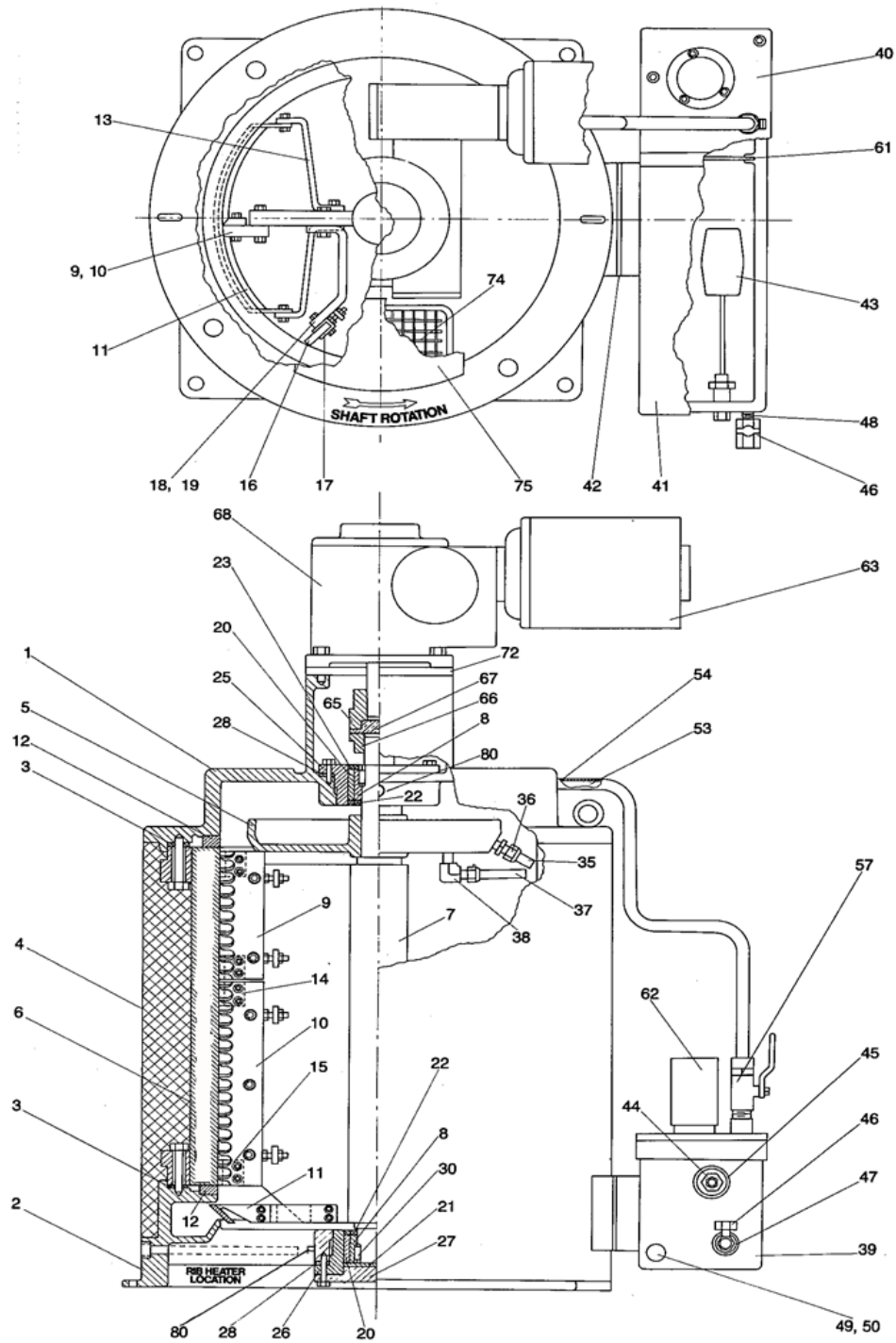

Drwg #	Nº de artículo	Nº de repuesto	Descripción	Qty Rea	Foto de parte
--------	----------------	----------------	-------------	---------	---------------

76RL

	0	53009	kit de mantenimiento semestral	1	
	0	53010	kit de mantenimiento anual	1	
	0	53018	Kit de mantenimiento de 3 años (incluye limpiador, desinfectante, grasa de grado alimenticio, kit de ajuste de la cuchilla de hielo y escobilla de goma)	1	
	0	53023	Kit de mantenimiento de 5 años (incluye limpiador, desinfectante, grasa de grado alimenticio, kit de ajuste de la cuchilla de hielo y escobilla de goma)	1	
	0	53026	Kit de reacondicionamiento de baja temperatura ambiente (calentadores de 500 W)	1	
	0	53032	Kit de reparación de escobilla de goma, Incluye escobilla de goma, envoltorio, tuercas y arandelas	1	
	0	53037	Kit del deflector de hielo	1	
c	0	53052	Válvula solenoide de línea de líquido para escamas de circuito doble	2	
c	0	53053	Electroválvula de línea de líquido con bobina	1	
c	44	CNBHF-SG-BR08	Montaje de válvula de flotador de agua	1	
c	53	CNM-SG-BR14X12	Racor de tubo de agua	1	
	0	E10E15	Juego de galgas de espesores	1	

Drwg #	Nº de artículo	Nº de repuesto	Descripción	Qty Rea	Foto de parte
b, c	9	E20E2	Cuchilla de hielo 12.5"	1	
b	0	E20E6	tuercas, pernos y arandelas para E20E2	1	
b	0	E20E7	tuercas, pernos y arandelas para Raspador de hielo auxiliar	2	
c	10	E30E3	Cuchilla de hielo 20.5"	1	
b, c	0	E30E5	tuercas, pernos y arandelas para E30E3	1	
b, c	14	E30E6	Raspador de hielo auxiliar	2	
c	8	E50D2	Manga del eje (SS)	2	
c	19	E50F1	soporte de la escobilla de goma (inferior)	1	
c	11	E50G5	Hoja deflectora de hielo	1	
c	13	E50G9	Soporte deflector de hielo	2	
c	5	E50H1	Bandeja de distribución de agua (tubos no incluidos)	1	
c	40	E50H11	Tapa del perno del sumidero de agua (lado de la bomba)	1	
c	41	E50H15	Tapa extraíble del sumidero de agua	1	
c	43	E50H18	Válvula de flotador de agua	1	

Drwg #	Nº de artículo	Nº de repuesto	Descripción	Qty Rea	Foto de parte
c	35	E50H19	Caño lateral de distribución de agua y accesorios	11	
c	57	E50H24	Válvula reguladora de tubo de agua	1	
c	37	E50H31	Distribución de agua Caño inferior y accesorio	1	
c	53	E50H38-KT	Kit de tubo de agua con racor	1	
c	0	E50H45	Conjunto de sumidero de acero inoxidable con bomba	1	
c	0	E50H8	Depósito de sumidero de agua Aluminio fundido (sin tapas)	1	
c	0	E50H8-KT	Descripción Sumidero de agua de aluminio fundido (con tapas)	1	
c	12	E50J1	Anillo aislante	2	
c	3	E50J2	Espaciador de orejeta aislado	8	
c	42	E50J3	Junta de sumidero de agua	1	
	0	E50J6	Herramienta de reparación de anillo aislante	1	
c	20	E50K1	Cojinete de manguito del eje principal	2	
c	0	E50K10	Kit de cojinete superior (cojinete, manguito y sellos)	1	
c	0	E50K11	Kit de cojinete inferior (cojinete, manguito, sello y placa)	1	

Drwg #	Nº de artículo	Nº de repuesto	Descripción	Qty Rea	Foto de parte
c	22	E50K14	Sello de grasa del cojinete principal (cromado)	3	
c	21	E50K2	placa de empuje del cojinete inferior	1	
c	25	E50K3	Retenedor de cojinete principal superior	1	
c	0	E50K3-KT	Conjunto de retenedor de cojinete superior (E50K10, E50K3 y E50K6)	1	
c	26	E50K4	Retenedor de cojinete principal inferior	1	
c	0	E50K4-KT	Conjunto de retenedor de cojinete inferior (E50K11, E50K4 y E50K6)	1	
c	27	E50K5	Cubierta de cojinete inferior	1	
c	28	E50K6	Arandela extraíble del cojinete principal	2	
c	63	E50M4	Motor de accionamiento 208-230-460 / 3 / 50-60 1 HP TEFC	1	
c	63	E50M5	Motor de accionamiento 220-380 / 3/50, 1 HP, TEFC	1	
c	63	E50M6	Motor de accionamiento 208-230 / 1/60, 1 HP, TEFC	1	
c	63	E50M7	Motor de accionamiento 200-220 / 1/50, 1 HP, TEFC	1	
c	65	E50N1	Acoplamiento flexible	1	
c	62	E50Q1	Bomba de agua 230-460 / 3 / 50-60	1	

Drwg #	Nº de artículo	Nº de repuesto	Descripción	Qty Rea	Foto de parte
c	62	E50Q2	Bomba de agua 220-230 / 1 / 50-60	1	
c	62	E50Q9	Bomba de agua 575/3/60	1	
c	68	E50R1-935	Reductor de velocidad 60 ciclos 750: 1	1	
c	68	E50R2-935	Reductor de velocidad 50 ciclos 600: 1	1	
c	7	E75D1	Eje principal	1	
c	18	E75F1	soporte de la escobilla de goma (superior)	1	
c	16	E75F3	Escurridor de agua	1	
c	17	E75F4	Envoltura de escobilla de goma	1	
c	0	HT500-240- 037X80	Calentador de costillas de repuesto de 500 vatios cada uno	3	
b	0	SR-OIL-SYN	aceite sintético reductor de velocidad (cuarto de galón)	1	