



Máquina de hielo en escamas

Lista de piezas de repuesto  
para el  
modelo 2000RLE

Howe Corporation

1650 N Elston Ave

Chicago, Il.60642

email: [parts@howecorp.com](mailto:parts@howecorp.com)

[Service@howecorp.com](mailto:Service@howecorp.com)

telefono principal: +1.773.235.0200

Partes: +1.773.687-4950











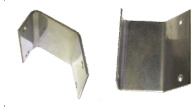

Servicio: +1.773.687.4940



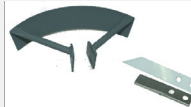























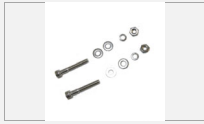
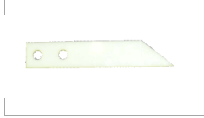

Drwg #	Nº de artículo	Nº de repuesto	Descripción	Qty Rea	Foto de parte
--------	----------------	----------------	-------------	------------	---------------

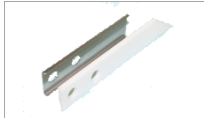

2000RLE

	0	53009	kit de mantenimiento semestral	1	
	0	53010	kit de mantenimiento anual	1	
	0	53015	Kit de mantenimiento de 3 años (incluye limpiador, desinfectante, grasa de grado alimenticio, filtro de agua, kit de ajuste de la cuchilla de hielo y escobilla de goma)	1	
b	17	53027	Kit de reparación de escobilla de goma, Incluye escobilla de goma, envoltorio, tuercas y arandelas	1	
b	0	53035	Kit del deflector de hielo	1	
b	0	53049	Electroválvula de línea de líquido con bobina	1	
b	75	E10A5	Tapa de inspección	1	
b	27	E10B8	Tapa del cojinete inferior	1	
b	0	E10C14	Adaptador de sudor Rotolock (línea de succión)	1	
b	0	E10C21	Conector del evaporador de la línea de líquido	1	
	7	E10D2	Eje principal de 2000	1	
	0	E10E15	Juego de galgas de espesores	1	
b	9	E10E2	Cuchilla de hielo 8.5"	1	

Drwg #	Nº de artículo	Nº de repuesto	Descripción	Qty Rea	Foto de parte
b	0	E10E5	tuercas, pernos y arandelas para E10E2	1	
b	19	E10F11	Soporte del escurridor	1	
b	17	E10F4	Escurridor 8.5"	1	
b	0	E10F4-OZ	Escurridor 8.5" (Resistente al ozono)	1	
b	0	E10F7	Soporte del escurridor (Solo modelos de agua de mar)	1	
b	0	E10F8	tuercas, pernos y arandelas para Envoltorio del escurridor	1	
b	18	E10F9	Envoltorio del escurridor 8.5"	1	
b	11	E10G1	Deflector de hielo	1	
b	0	E10G6-KT	Kit del deflector de hielo	1	
b	37	E10H17	Caño inferior de distribución de agua	1	
b	35	E10H18	Tubo y accesorio de salida lateral de distribución de agua (para bandeja de distribución de aluminio de estilo antiguo)	6	
b	5	E10H51	Kit del contenedor de distribución de agua	1	
a, b	0	E10H59	Válvula de regulación de agua	1	
b	57	E10H59	Válvula de regulación de agua	1	

Drwg #	Nº de artículo	Nº de repuesto	Descripción	Qty Rea	Foto de parte
b	0	E10H61-P	conjunto de cárter de agua de repuesto para modelo RLE	1	
b	53	E10H67-KT	tubo de agua con válvula reguladora	1	
b	35	E10H73	Tubo de salida lateral de distribución de agua (para bandeja de distribución de plástico) Tubo de salida lateral de distribución de agua (para bandeja de distribución de plástico)	6	
a, b	0	E10H79	Válvula flotante	1	
b	12	E10J1	Anillo aislante	2	
	0	E10J8	Herramienta de reparación de anillos aislantes	1	
b	0	E10N4	Acoplamiento flexible	1	
b	62	E10Q5-P	bomba de agua de repuesto con enchufe Molex (anterior a abril de 2006)	1	
a, b	18	E10Q7-P	Bomba de agua	1	
b	62	E10Q7-P	bomba de agua de repuesto con enchufe Molex	1	
b	68	E10R5	Reductor de velocidad (todo 2000, 3000- 50Hz usar) 600:1	1	
b	68	E10R7	Reductor de velocidad (todo 2000, 3000- 50Hz usar) 600:1	1	
b	0	E10T1	Juego de herramientas de remoción de cojinetes	1	
b	14	E20E4	Raspador de hielo auxiliar	2	

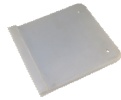
Drwg #	Nº de artículo	Nº de repuesto	Descripción	Qty Rea	Foto de parte
b	0	E20E7	tuercas, pernos y arandelas para Raspador de hielo auxiliar	2	
b	16	E20G4	Raspador deflector de hielo (solo)	1	
b	0	E20G5	tuercas, pernos y arandelas para deflector de hielo	1	
b	0	E20G6	tuercas, pernos y arandelas para Deflector de hielo	1	
b	0	E20G7	Placa trasera del raspador deflector de hielo	1	
b	0	E20G9-KT	Kit del raspador del deflector de hielo	1	
b	42	E20J2	Junta del sumidero de agua	1	
b	3	E20J4	Espaciador de orejeta aislante	8	
b	20	E20K1	Cojinetes principales	2	
b	21	E20K2	Placa de empuje del cojinete inferior	1	
b	22	E20K3	Sello de grasa del cojinete principal	3	
b	0	E20K4	Juego de cojinetes, Retenes de aceite Cojinetes de rodadura Disco del cojinete inferior Junta	1	
b	63	E20M3-P	Motor de accionamiento de repuesto con enchufe Molex 1/3 HP, 230/1/60 (TEFC)	1	
b	56	ELM-CT-NY10X08	racor de tubo de agua	2	

Drwg #	Nº de artículo	Nº de repuesto	Descripción	Qty Rea	Foto de parte
a	0	F5H25-4	Tapa del sumidero de agua	1	
b	0	HT150-240-037X50	elemento calefactor bajo ambinet de repuesto	3	
b	0	SR-OIL-SYN	aceite sintético reductor de velocidad (cuarto de galón)	1	