

HOWE[®]

Rapid Freeze[®] Ice Flakers

Máquina de hielo en escamas

Lista de piezas de repuesto
para el
modelo 6000RL

Howe Corporation

1650 N Elston Ave

Chicago, Il.60642

email: parts@howecorp.com

Service@howecorp.com

telefono principal: +1.773.235.0200

Partes: +1.773.687-4950

Servicio: +1.773.687.4940

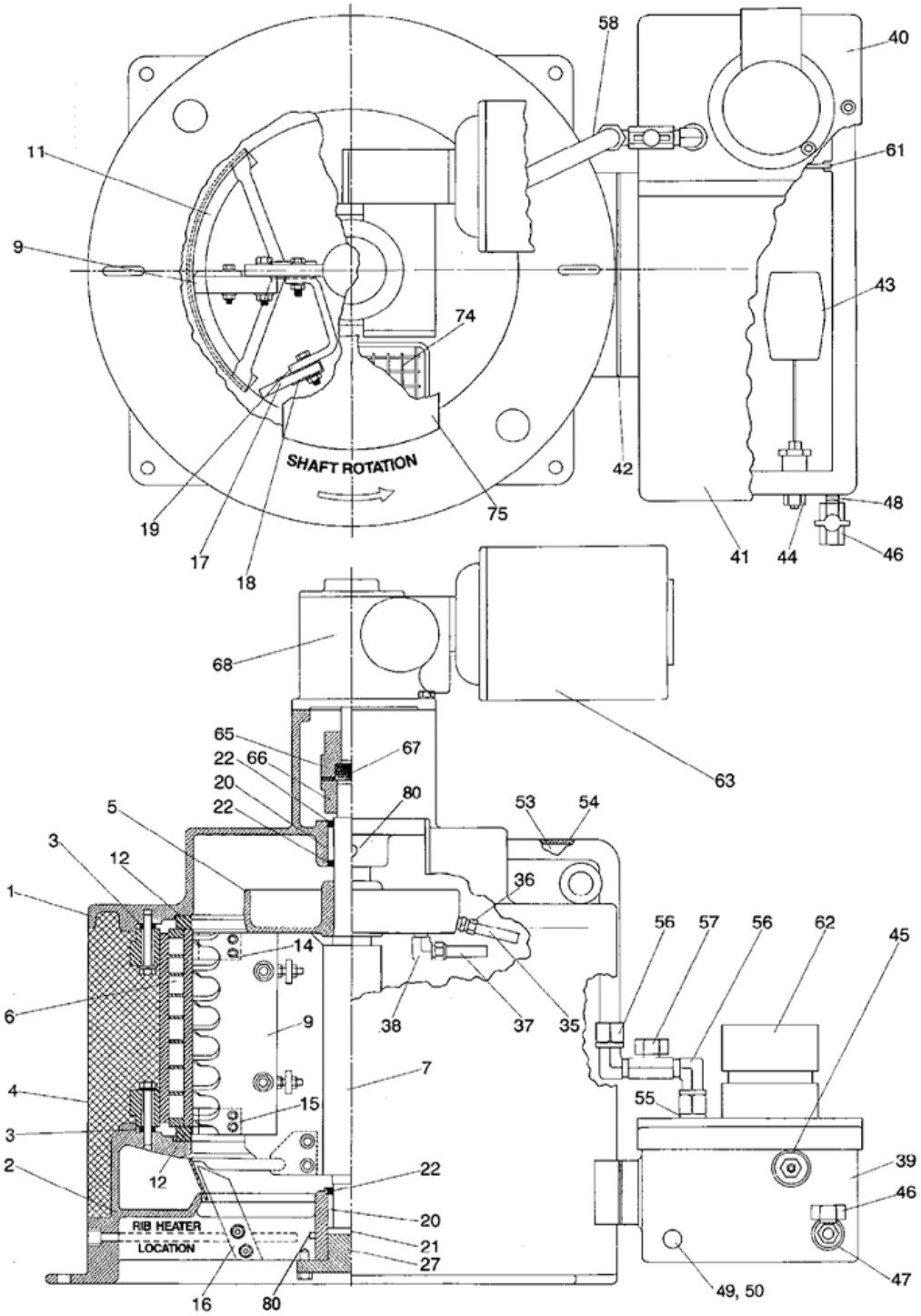

Drwg #	Nº de artículo	Nº de repuesto	Descripción	Qty Rea	Foto de parte
--------	----------------	----------------	-------------	---------	---------------



6000RL

b	3	E20J4	Espaciador de orejeta aislante	8	
b	7	E30D4	Eje principal de 6000	1	
b	9	E30E3	Cuchilla de hielo 20.5"	1	
b, c	0	E30E5	tuercas, pernos y arandelas para E30E3	1	
	0	E10E15	Juego de galgas de espesores	1	
b	11	E20G2	Deflector de hielo	1	
b	0	E20G8-KT	Kit del deflector de hielo	1	
b	0	53036	Kit del deflector de hielo	1	
b	0	E20G5	tuercas, pernos y arandelas para deflector de hielo	1	
b	12	E20J1	Anillo aislante	2	
	0	E10J8	Herramienta de reparación de anillos aislantes	1	
b	14	E20E4	Raspador de hielo auxiliar	2	
b	0	E20E7	tuercas, pernos y arandelas para Raspador de hielo auxiliar	2	
b	16	E20G4	Raspador deflector de hielo (solo)	1	

Drwg #	Nº de artículo	Nº de repuesto	Descripción	Qty Rea	Foto de parte
b	0	E20G7	Placa trasera del raspador deflector de hielo	1	
b	0	E20G9-KT	Kit del raspador del deflector de hielo	1	
b	0	E20G6	tuercas, pernos y arandelas para Deflector de hielo	1	
b	17	53030	Kit de reparación de escobilla de goma, Incluye escobilla de goma, envoltorio, tuercas y arandelas	1	
b, c	17	E30F3	Escurridor 20.5"	1	
b	0	E30F3-OZ	Escurridor 20.5" (Resistente al ozono)	1	
b	18	E30F8	Envoltorio del escurridor 20.5"	1	
b	0	E30F22	tuercas, pernos y arandelas para Envoltorio del escurridor	1	
b	19	E30F7	Soporte del escurridor	1	
b	0	E30F21	Soporte del escurridor (Solo modelos de agua de mar)	1	
b	20	E20K1	Cojinetes principales	2	
b	21	E20K2	Placa de empuje del cojinete inferior	1	
b	22	E20K3	Sello de grasa del cojinete principal	3	
b	0	E20K4	Juego de cojinetes, Retenes de aceite Cojinetes de rodadura Disco del cojinete inferior Junta	1	

Drwg #	Nº de artículo	Nº de repuesto	Descripción	Qty Rea	Foto de parte
b	0	E10T1	Juego de herramientas de remoción de cojinetes	1	
b	27	E20B8	Tapa del cojinete inferior	1	
b	35	E30H8	Caño lateral de distribución de agua	7	
b	37	E20H38	Caño inferior de distribución de agua	1	
b	5	E30H9	Kit del contenedor de distribución de agua	1	
b	41	E20H10	Tapa de aluminio extraíble para cárter de agua	1	
b	41	E20H9	Tapa del cárter de agua (lado de la bomba)	1	
b	42	E20J2	Junta del sumidero de agua	1	
b	43	E50H18	Válvula de flotador	1	
b, c	44	CNBHF-SG-BR08	accesorio de mamparo de válvula de flotador de agua	1	
b	53	E10H67-KT	tubo de agua con válvula reguladora	1	
b	56	ELM-CT-NY10X08	racor de tubo de agua	2	
b	57	E10H59	Válvula de regulación de agua	1	
b	61	E20H13	pantalla de sumidero de agua	1	

Drwg #	Nº de artículo	Nº de repuesto	Descripción	Qty Rea	Foto de parte
b	62	E30Q1	bomba de agua de repuesto	1	
b	0	E30H7	conjunto de cárter de agua de repuesto	1	
b	0	E20Q5	Bomba de agua de reemplazo para servicio marítimo (a bordo)	1	
b	63	E30M1	Motor de accionamiento de repuesto 1/2 HP, 230/1/60 (ODP)	1	
b	63	E30M3	Motor de accionamiento de repuesto 1/2 HP, 220/1/50	1	
b	63	E20M12	Motor de accionamiento de repuesto 1/2 HP, 240/1/50	1	
b	63	E30M5	Motor de accionamiento de repuesto 1/2 HP, 280/3/50	1	
b	63	E20M2	Motor de accionamiento de repuesto 1/2 HP, 460/3/60	1	
b	0	E20N9-H	Acoplamiento flexible	1	
b	68	E20R4	Reductor de velocidad: 60Hz 600:1	1	
b	68	E20R3	Reductor de velocidad; 50Hz 450:1	1	
b	75	E20A6	Tapa de inspección	1	
b	0	HT150-240-037X50	elemento calefactor bajo ambinet de repuesto	3	
b	0	SR-OIL-SYN	aceite sintético reductor de velocidad (cuarto de galón)	1	

Drwg #	Nº de artículo	Nº de repuesto	Descripción	Qty Rea	Foto de parte
b	0	53051	Electroválvula de línea de líquido con bobina	1	
	0	53011	Kit de mantenimiento semestral (incluye limpiador, grasa de grado alimenticio y filtro de agua)	1	
	0	53012	Kit de mantenimiento anual (incluye limpiador, desinfectante, grasa de grado alimenticio, filtro de agua y kit de ajuste de la cuchilla de hielo)	1	
	0	53017	Kit de mantenimiento de 3 años (incluye limpiador, desinfectante, grasa de grado alimenticio, filtro de agua, kit de ajuste de la cuchilla de hielo y escobilla de goma)	1	